



सत्यमेव जयते

MINISTRY OF RURAL DEVELOPMENT

# RURAL ROAD MAINTENANCE TRAINING MODULES FOR CONTRACTORS

## Module-5 APPROPRIATE SETTING OUT TECHNIQUES







Ministry of Rural Development

# RURAL ROAD MAINTENANCE TRAINING MODULES FOR CONTRACTORS

## Module-5 Appropriate Setting Out Techniques



This training module is produced through a collaborative effort between the International Labour Organization and the National Rural Road Development Agency under the technical assistance component of the World Bank supported Rural Roads Project-II of Pradhan Mantri Gram Sadak Yojana Project (PMGSY).

---

### **Contents:**

- Setting out tools
- Setting out techniques
- Quality control aids/templates

### **Learning Objective:**

At the end of this Module you are expected:

- Use various basic setting out aids
- Set out side drains
- Check that the side drains are cleared for free flow of water
- Set out mitre drains and find the end of excavation
- Set out road cross-section of road

### **Acknowledgement**

The following publications were also used as reference materials:

- Building Rural Roads, Bjorn Johannessen, International labour Organization, ILO Regional Office for Asia and the Pacific, 2008
- A Practitioner's Guide to Rural Roads Improvement and Maintenance, International Labour Organization and Government of Ghana, 2014

## Foreword

---

Pradhan Mantri Gram Sadak Yojana (PMGSY), was launched in December, 2000 as a special intervention of the Government of India with the broad objective of ensuring sustainable poverty reduction. The scheme aims to provide good quality all-weather single connectivity to every eligible habitation. Rural roads are a state subject under the Constitution and as such are the basic responsibility of the states. However under the PMGSY, the construction of good quality and well-engineered roads are fully funded by the central government. Maintenance of these roads is the responsibility of the states. The year 2013 saw the launch of PMGSY-II with the objectives of consolidating the existing rural road network and upgrading existing rural roads that provide connectivity to rural growth centres. PMGSY-II envisages sharing of construction costs between the Centre and the states with maintenance costs continuing to be funded fully by the states.

Over the last 14 years, the PMGSY has carved out a place for itself as a programme characterised by creation of good quality assets, effective management and technical proficiency by the National Rural Road Development Agency (NRRDA), along with capable state road agencies. For implementation and operations, the involved agencies have been supported with detailed documentation in the form of programme guidelines, an operations manual, standard bidding documents, specifications, a standard data book, a procurement and contracts management manual and the Quality Assurance Hand Book with support from the Indian Roads Congress. These documents have also contributed significantly towards effective implementation of PMGSY and even for mainstreaming good practices in other rural roads programmes being executed by the states from their own resources.

An area of concern has been lack of regular maintenance as per the “Programme Guidelines”. However, in recent years, there has been increased awareness and commitment to maintenance by the states. The tempo needs to be sustained and further accelerated.

Under the technical assistance component of the World Bank supported Rural Roads Project-II, the International Labour Organization (ILO), in collaboration with NRRDA has prepared a manual “Managing Maintenance of Rural Roads in India”. This initiated the execution of maintenance works and the development of these training modules for engineers and contractors associated with rural road maintenance works. To strengthen such activities in the participating states of RRP-II, a series of training of trainers workshops were arranged at national and state level based on the course material developed.

The training modules broadly cover the principles for maintenance management of rural roads, planning and execution of common maintenance interventions to ensure reliable transport services and safety to users and the local communities served by the rural roads, and arrangements for monitoring the performance of contractors engaged for the task.

I would like to acknowledge the support of all those associated with the development of these training modules, especially the ILO and its technical assistance team, Mr. Htun Hlaing, Mr. Bjorn Johannessen and the project's Rural Roads Maintenance Engineers. I would also place on record the valuable suggestions of my colleagues Ms. Manju Rajpal, IAS, (ex Director – RC), Mr. R. Basavaraja, Director NRRDA, Mr. S. S. Bhatia, Deputy Director, NRRDA, Mr. A. K. Sharma, Consultant World Bank and senior engineers as well as secretaries from State Governments in bringing the document to its present shape.

I sincerely believe, the training modules would be found useful for the states in their efforts to secure adequate maintenance of all rural roads, not merely the PMGSY roads and improve maintenance practices so that benefits of access continue to remain available for our rural people on a sustainable basis.

(Rajesh Bhushan, IAS)  
JS (RC) & DG, NRRDA  
Ministry of Rural Development  
Government of India

October, 2015



# Introduction to Training Modules

---

The purpose of this training manual is to provide technical management staff and contractors with appropriate guidelines for the effective management of road maintenance works. The training modules are based on the manual “Managing Maintenance of Rural Roads in India”. These modules broadly cover the principles for maintenance management of rural roads, planning and execution of common maintenance interventions to ensure reliable transport services and safety to users and the local communities served by the rural roads. The arrangements for monitoring the performance of contractors engaged for the task are also covered in these modules.

This manual is broken down into the following categories composed of different modules:

Module 1: INTRODUCTION

Module 2: TECHNICAL CONSIDERATIONS AND IMPLEMENTATION ARRANGEMENTS

Module 3: CONSTRUCTION MEASUREMENT AND BASIC CALCULATIONS

Module 4: PLANNING AND WORK ORGANISATION

Module 5: APPROPRIATE SETTING OUT TECHNIQUES

Module 6: HAND TOOLS, EQUIPMENT & CONSTRUCTION MATERIALS

Module 7: ROUTINE MAINTENANCE WORK METHODS

Module 8: OCCUPATIONAL HEALTH & SAFETY, ENVIRONMENTAL ISSUES AND DECENT WORK

Module 9: COSTING AND TENDERING

The trainer may decide to conduct a full course consisting of all the nine modules or may selectively conduct specific modules depending on the needs of the target group.

As a general advice the trainer should:

- **Encourage active participation**

There is sometimes a tendency of the trainer to act like a teacher in school and to read or lecture directly from the course material. This behaviour should be avoided. Trainees remember information better if they participate actively in discussions and if there is a free exchange of views and of questions between everyone participating in the course.

- **Guiding the discussion**

There are times during a discussion when everyone wants to speak at the same time. When such situations arise, the trainer should insist that the group listen to one person at the time. If one speaker hijacks the floor too long, the trainer needs to interrupt, pointing out that other participants may also want to speak.

- **Listen attentively**

Equal attention should be paid to each speaker. Listen attentively and let the speaker understand that ideas and opinions expressed are both interesting and relevant. It is sometimes useful to take a brief note of participants' suggestions while they are speaking, noting them down on a flipchart or blackboard. A summary of these notes may prove useful for later discussions.

- **Emphasise important points**

Each time the participants make an important point or expresses an interesting opinion, the trainer should draw the group's attention to it by repeating the idea in simple terms which are understood by the majority of the trainees.

- **Preparing the sessions**

When trainees only listen to a description of how a particular job should be done, they are likely to forget what they heard. If however, they actually carry out the task concerned, they will remember how to do it. For this reason, every effort should be made to include as many practical exercises and demonstrations as possible, be they carried out on the worksite or in the training room. Practical sessions should always be carefully planned in advance.

- **Recapping**

A discussion is more than just a conversation. A subject is discussed with an aim in mind. It may occasionally be worthwhile recapping the topic considered and recalling the aim of the discussion by intervening from time to time to give a brief summary of the main points dealt with so far.

- **Questioning**

An important role of the trainer is to ensure that the atmosphere during training is sufficiently relaxed to allow participants to feel at ease to speak freely. Questions set by the trainer should not be regarded by the trainees as tests. Often there is no strict "right or wrong" answer to a question, except for mathematics. Questions should simply give your trainees the opportunity to put forward their individual points of view.



# Table of Contents

---

<b>5. APPROPRIATE SETTING OUT TECHNIQUES</b>	<b>1</b>
5.1 INSTRUMENTS USED FOR SETTING OUT	1
5.1.1 Tape measure	1
5.1.2 Ranging rod and profile board	1
5.1.3 Boning rods	2
5.1.4 Line level and builders line	2
5.1.5 Templates	4
5.2 BASIC SETTING-OUT TECHNIQUES	5
5.2.1 Setting out straight sections	5
5.2.2 Setting out right angle using tape measure	7
5.2.3 Setting out right angle using string	8
5.2.4 Setting-out a 45° angle	10
5.2.5 Setting-out 30° and 60° angle	10
5.2.6 Transferring levels	11
5.2.7 Establishing new levels	13
5.2.8 Measuring gradient using line level	13
5.2.9 Setting out predefined gradient using line level	14
5.2.10 Adjusting vertical levels in a drain	16
5.2.11 Setting out outfall (mitre drain)	18
5.2.12 Setting out cross section of road	19



# Appropriate Setting Out Techniques

## 5.1 INSTRUMENTS USED FOR SETTING OUT

Setting out may be done by employing simplified instruments and aids or sophisticated capital Intensive Survey instrument such as Theodolites, GPS, etc.

However this section focuses on the correct use of simple instruments and aids which are readily available locally and appropriate for accurately setting-out rural road works.

The following are some of the most commonly used setting out instruments used in labour-based works:

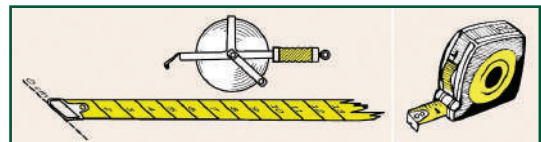
- Tape measures
- Boning rods
- Templates
- Ranging rods
- Profile boards
- Line level and builders line

Some of the setting out tools, instrument and aids are shown below and their uses.

### 5.1.1 Tape measure

A great variety of tape measures exist. The most common length of tape measure used for setting out is 30m long. The tapes are made of steel or linen. Although the former is stronger, the numbers/ marking on the tape becomes unreadable after a period of use. It can also be used for setting-out a right angle. It should be noted that the zero point is not always located at the same place on different tape measures.

Figure 1: Various types of tape measures



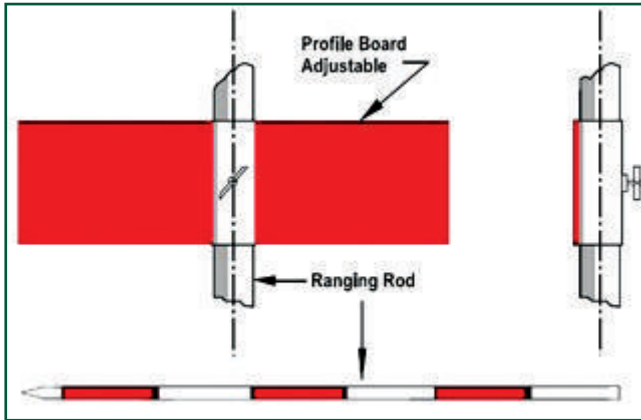
### 5.1.2 Ranging rod and profile board

Ranging rods are sticks usually 2m long with a diameter of approximately 2.5cm. They are made of various materials (metal, hard plastic, wood) and are usually provided with a pointed metal end. They are painted alternately red and white with black marking at the 1-metre point. It is used for setting out straight lines and other alignments.

A profile board is designed in such a way that it can be attached to a ranging rod. It has a screw mechanism that enables the profile board to slide up and down on the ranging rod and be fixed at any desired point simply by tightening the screw. A long-lasting profile board is one made from thin steel

plate (40cm x 10cm) welded to a short length of metal tubing that can slide up and down and can be clamped to the metal rod.

**Figure 2:** *Profile board and ranging rod*



It is used for controlling vertical alignment, checking or setting gradients.

### 5.1.3 Boning rods

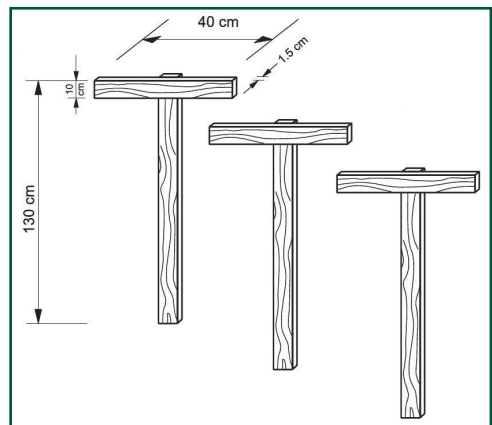
Boning rods are T-shaped and of a uniform height. They can easily be manufactured by nailing a wooden lath of 40cm length and 10cm height on to another lath of 130cm length and 10cm width so that the end result looks like a 'T'. The horizontal lath should be painted in clearly visible colours. Boning rods have to be used in a set of three.

The function of the boning rods is to check a vertical alignment by eye, in order to see if a section has an even gradient, whether on level ground, or on rising or falling gradients.

*For example to check a section of mitre drain in flat country, where it is essential to verify that the drain invert falls at an even slope of 2%.*

It is used for controlling vertical alignment. (e.g. invert level of side drains).

**Figure 3:** *Boning rods*



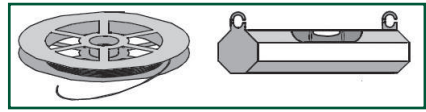
### 5.1.4 Line level and builders line

A line level is a small spirit level about 80mm to 120mm in length. It has a hook on each end, which is used for hooking the level on to a smooth line.



The level is used together with a builder's line, ranging rods (or profile boards) and a tape measure. The line level requires two people to operate. The line level is used for taking the levels of points i.e. for checking how the height of one point varies from another.

**Figure 4:** *Line level and builder's line*



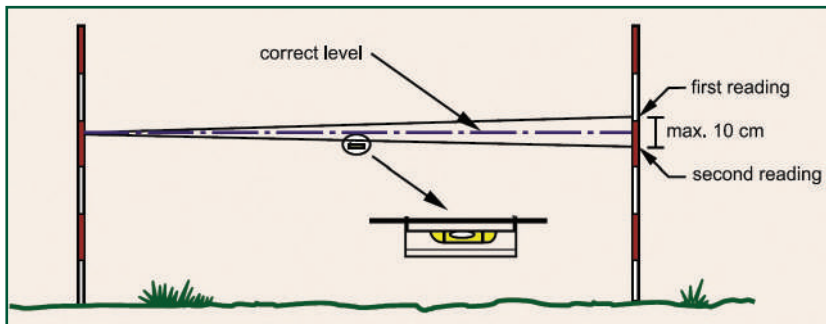
Always check:

- That the builder's line (string) is smooth or of nylon
- That the builder's line (string) is tight
- The line level is in the middle between the two ranging rods
- The accuracy of the level regularly

The accuracy of the line level can be checked as shown below (refer to Figure 5):

- Place two ranging rods 20m apart
- Fix a line on the 1m-mark on one rod and transfer the level to the other rod; mark this level
- Keep line in place and turn the level round
- Adjust line again and mark the new level and measure the difference between the two levels; if difference is less than 10cm the correct level is exactly in the middle of the two marks, if the difference is more than 10cm the level should be changed.

**Figure 5:** *Checking accuracy of line level*



### 5.1.5 Templates

Templates are used to control certain shapes of the road camber, ditches and canals. Most common templates used in labour-based road works are Ditching template (used for control/checking side drain/ ditch), Sloping template (used for controlling/checking the fore-slope of side drains as shown in Figure 6), Camber board as shown in Figure 7 (for checking camber of gravel and earth roads which comes in sets – un-compacted camber board used when

forming camber and compacted camber board for checking the compacted camber and gravelling). A template of the standard slope-ditch size can be used by the labourers to check continuously whether the correct shape is dug. Templates are usually made of wood or welded metal and tailor-made for each particular standard size of the drains, in accordance with the technical specifications.

**Figure 6:** *Sloping template*



**Figure 7:** *Checking camber with camber-board*



Templates are very useful control aids as any labour can see the exact size and shape of the work she or he is required to carry out.

## 5.2 BASIC SETTING-OUT TECHNIQUES

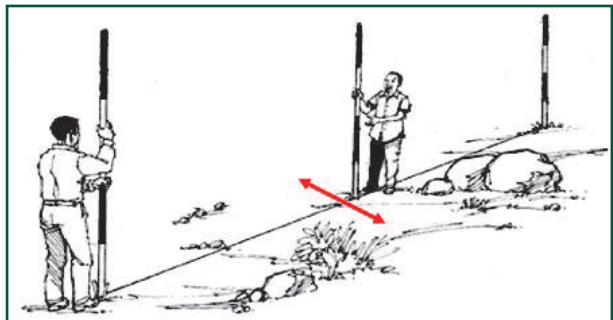
### 5.2.1 Setting out straight sections

For most road works alignment must be established, for example the center line of a road, side drains, etc. Where there are properly defined existing roads, the existing road will show the alignment and measurements can be taken from offset from the existing road.

#### *Interpolation*

The two end points of the straight line to be established are each marked with a ranging rod. The intermediate points can be found by sighting from one end rod to the other and moving a third rod until it is aligned with the two end rods (see Figure 8).

**Figure 8:** *Setting out straight by interpolation*



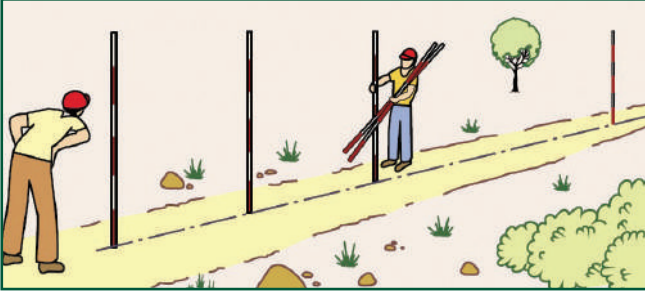




## Extrapolation

The same procedure can be used to extend a straight line (see Figure 9). Place two ranging rods at a certain distance, e.g. 10m, along the line you would like to establish. Walk with the third rod to the next point of the line, e.g. another 10m ahead. Sight the first two rods and shift the third rod until all three rods are in a straight line. Mark this point with a peg and repeat the same procedure every 10m until you have reached the end of your straight line. Check the entire line again.

**Figure 9:** *Setting out straight by extrapolation*



### 5.2.2 Setting out right angle using tape measure

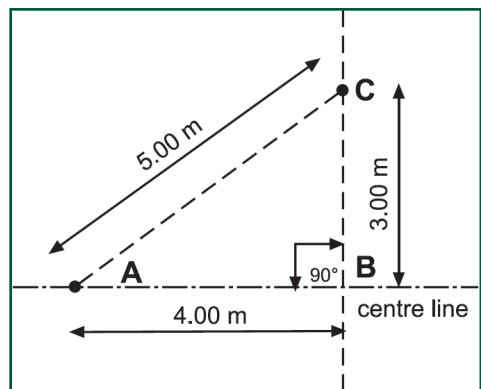
It is often necessary to measure an angle of 90 degrees during construction work, for example, when setting out a culvert and for construction or a cross section at right angles to the road center line.

A triangle, which has sides of length 3m, 4m and 5m, will always have a right angle between the 3-metre side and the 4-metre side. We can therefore use this knowledge to construct a right angle using only a tape measure. To help remember this useful information, we refer to the triangle as a “3 : 4 : 5 triangle”.

Procedure to construct a right angle using a tape to make a 3 : 4 : 5 triangle is as follows:

- Step 1: The right angle is established by measuring a triangle with side lengths of 3m, 4m and 5m as illustrated in Figure 10.
- Step 2: Measure the length AB of 4m along the defined center line. Set pegs exactly at points A and B. Hold the zero point of the tape measure on the peg A.

**Figure 10:** *Setting out a right angle by tape measure*



Step 3: A second person holds the 8m mark of the tape measure on peg B. A third person holds the tape measure at the 5m mark which will lead to point C when the tape measure is pulled tight.

The following procedure can also be used as an alternative method to set out a 3 : 4 : 5 triangle. A right angle can also be set out by a different method with only a tape measure, using the fact that ratio between the three sides is 3 : 4 : 5, as above, (3m + 4m + 5m). Procedure as follows:

Step 1: One man hold the 'zero' point and the '12.00' mark on the tape together,

Step 2: A second man holds a ranging rod at the point on the center line where the right angle is needed. He should run the tape outside the ranging rod, with the '3.00' mark on the tape held firmly against the ranging rod,

Step 3: The first man (holding the 'zero' and at '12.00' point) should now be positioned exactly on the center line, with the tape held firmly outside a ranging rod and taut between the two men,

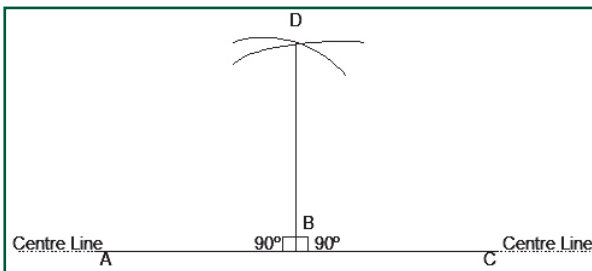
Step 4: A third man holds the tape firmly around another ranging rod at the '8.00' mark and move until the two remaining sides of the tape are taut.

This creates a triangle in the tape, with sides of 3m, 4m, and 5m. The angle between the center line and the 5m side (between the '3.00' and the '8.00' marks) is 90° or a right angle.

### 5.2.3 Setting out right angle using string

It is possible, with care, to construct a right angle with only a piece of string as equipment. The string must be between 5m and 10m long to give an accurate result. Figure 11 shows an illustration of setting out a right angle using a piece of string.

Figure 11: *Setting out a right angle by string*



Procedure to construct a right angle using a piece of string:

Step 1: Fold the string in half and tie a knot exactly in the middle,



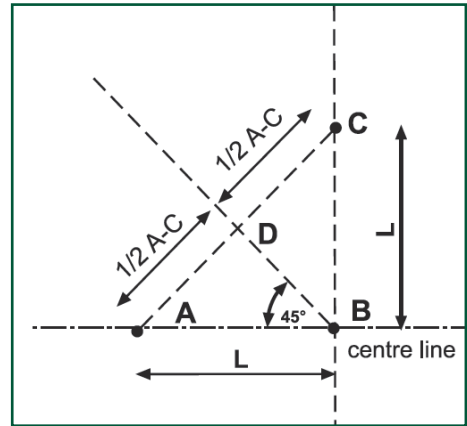
- Step 2: Align the string along the road center line (or any line of which the right angle is required), with the knot at the point where the right angle is needed (B),
- Step 3: Hammer in pegs (A and C) at either end of the string,
- Step 4: From peg A, swing an arc of the full length of the string,
- Step 5: From peg C, swing an arc of the full length of the string,
- Step 6: Mark the place (D) where the two arcs cross each other.

### 5.2.4 Setting-out a 45° angle

Sometimes it is necessary to set out a 45° angle such as when setting out wing-walls. The following procedure shows how to set out a 45° angle using string:

- Step 1: First establish a right angle as shown in the previous section.
- Step 2: Set out the same distance (L) on both of the two lines starting from the intersection point B, e.g. 3m, and fix pegs A and C.
- Step 3: Span a string line between points A and C and measure this length A to C. Divide the length A to C by two and set peg D exactly in the middle of this length.

Figure 12: Setting out 45° angle



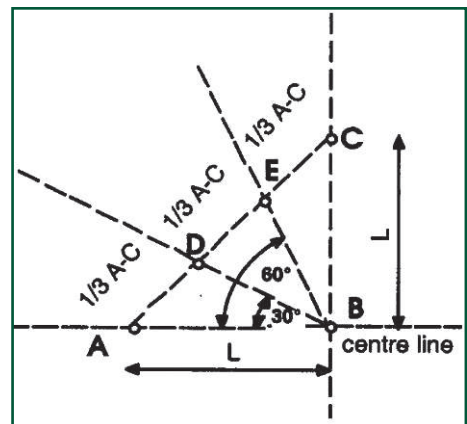
- Step 4: Establish the new line B to D with a string line and extend beyond peg D if necessary.

### 5.2.5 Setting-out 30° and 60° angle

Sometimes it is necessary to set out a 30° or 60° angle e.g. when setting out mitre drains. The following procedure shows how to set out a 30° or 60° angle using string:

- Step 1: First establish a right angle as shown in previous section.
- Step 2: Set out the same distance (L) on both of the two lines starting from the intersection point B, e.g. 3m, and fix pegs A and C.

Figure 13: Setting out 30° and 60°



- Step 3: Span a string line between points A and C and measure this length A to C. Divide the length A to C by three and set pegs D (for 30°) after one third of the length A to C, or E (for 60°) after two thirds of the length A to C.
- Step 4: Establish the new lines B to D or B to E with a string line and extend beyond peg D or E if necessary.

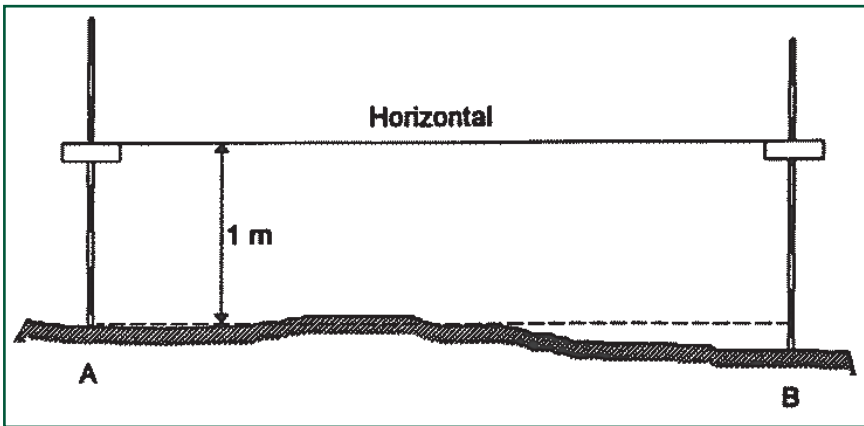
### 5.2.6 Transferring levels

Transferring of levels is needed when setting out cross sections, setting out drains, mitre drains and outlet drains.

The level at point A on the ground may be transferred to another B as follows:

- Step 1: Fix two ranging rods vertically in the ground at points A and B. Fix a level on the ranging rod at point A by making it or fixing a profile board at a definite distance above the ground, say 1m above the ground.
- Step 2: Fasten a string on the fixed level on the ranging rod at A and adjust the end of the stretched string at rod B until a line level hooked to it has its bubble centred. The string is now horizontal and the point where it touches the rod at B is marked. This point is at the same level as the point on the rod A (1m above ground).

Figure 14: *Transferring levels using line level*



- Step 3: Measure out 1m below the marked point on the ranging rod at B and mark this point too. This point will be at the same level as the ground level at point A. Note that if the ground level at B is higher than the ground level at A, the transferred level shall be below ground level. If the ground level at A is higher than B, then the transferred level shall fall above ground level.

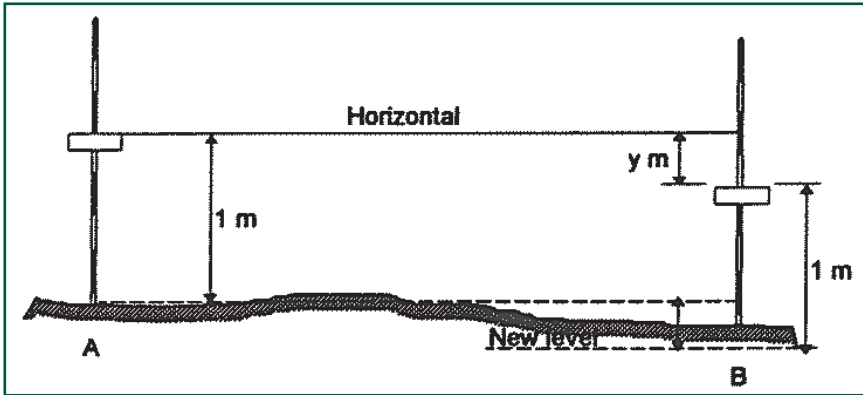


### 5.2.7 Establishing new levels

The following procedure involves setting out a defined level above or below another known level.

Step 1: Fix two ranging rods vertically in the ground at points A and B. Fix a level on the ranging rod at point A by marking it or fixing a profile board at a definite distance above the ground, say 1 m above the ground.

Figure 15: *Establishing new level using line level*



Step 2: By using a string and line level, obtain and mark point at B at the same level as the mark on the rod at A (1 m above). The horizontal level is attained when the spirit bubble is centred.

Step 3: If the new level required at B, say  $y$  meters above the level at point S, then obtain the difference of  $(1 - y)$  meters. Measure out this difference  $(1 - y)$  meters below the marked point on the ranging rod at B. this point will be  $y$  meters above the ground level at point A.

Note that if the difference becomes negative, measure out above the marked point of ranging rod at point B.

Step 4: Similarly, if the new level required at B, say  $y$  meters below the ground level at point A, then, add  $y$  meters to 1 m. Measure out this sum  $(1 + y)$  meters below the marked point on the ranging rod at B. this point will be  $y$  meters below the ground level at point A.

### 5.2.8 Measuring gradient using line level

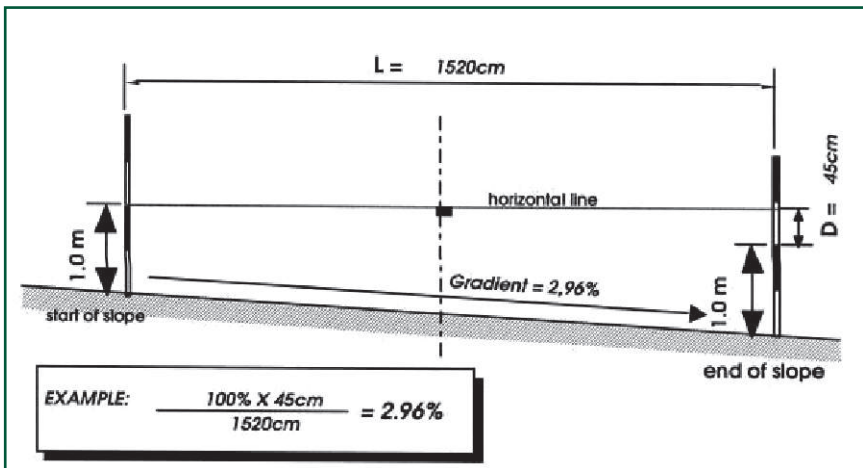
Step 1: Fix ranging rods vertically at the two end points of the slope firmly into the ground.

Step 2: Tie the string line at the 1 m mark of the ranging rod at the higher point of the slope.

- Step 3: Whilst holding the string line at the lower ranging rod, hook the line level at the middle point between the two ranging rods.
- Step 4: Move the string line at the lower point ranging rod up or down until the level bubble is exactly in the middle. Mark this level at the lower ranging rod, turn the line level around and mark the level again. Measure the middle of the difference of the two marks – this is the exact horizontal level transferred from the higher to the lower ranging rod.
- Step 5: Measure the difference between your horizontal level mark and the 1m mark at the ranging rod (= D).
- Step 6: Measure the exact distance (length) between the two ranging rods (= L).
- Step 7: Calculate the gradient (percentage) of the slope. The calculation is as follows:

$$\frac{D}{L} \times 100 = \text{Slope\%}$$

Figure 16: *Finding the gradient of a slope*



Note: Use centimetres for all measurements.

### 5.2.9 Setting out predefined gradient using line level

The following are steps involved in setting out gradients:

- Step 1: Define level difference D by dividing L by 100% and multiply by given gradient G in % (e.g. 3% as in the example below)
- Step 2: Fix the string line to the lower ranging rod so that the line is horizontal and mark the point on the other ranging rod.

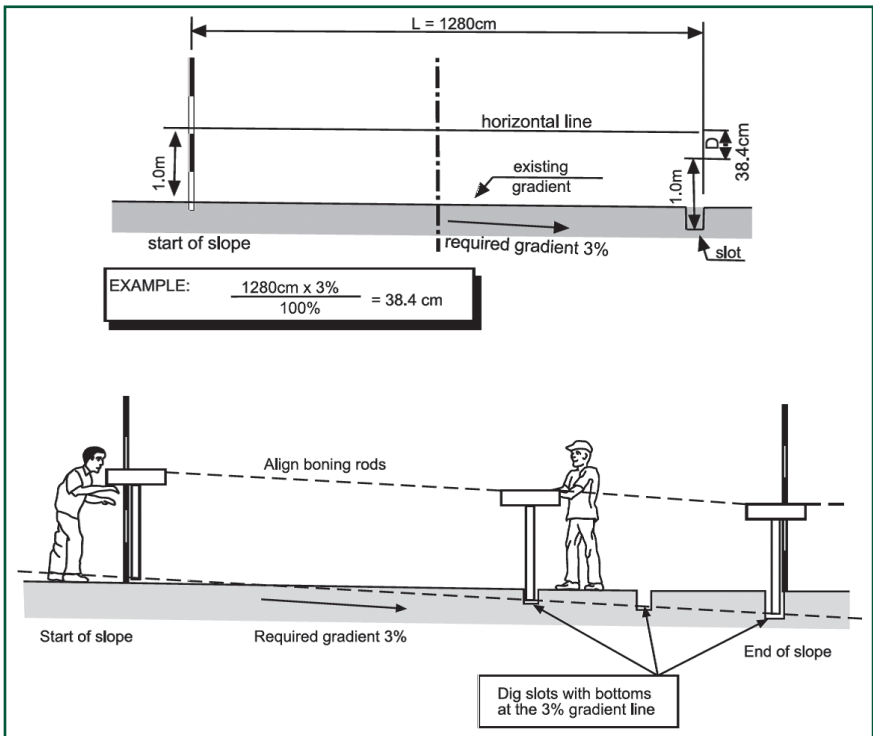




Step 3: Now add D to 1 meter and measure from the level mark downwards. You will see that in order to be able to measure this new height, you need to dig a small slot next to the ranging rod. Dig the slot in small steps until you can measure the exact height (D + 1) meters. The bottom of this slot is now at the required level.

Step 4: In order to transfer the gradient uniformly you have to use boning rods or profile boards. Set a boning rod at each end point, for every few meters dig a small slot, set the third boning rod (traveller) at the bottom of the slot and deepen or raise the slot until all three boning rods are in line with one another.

**Figure 17: Setting out a pre-defined gradient**

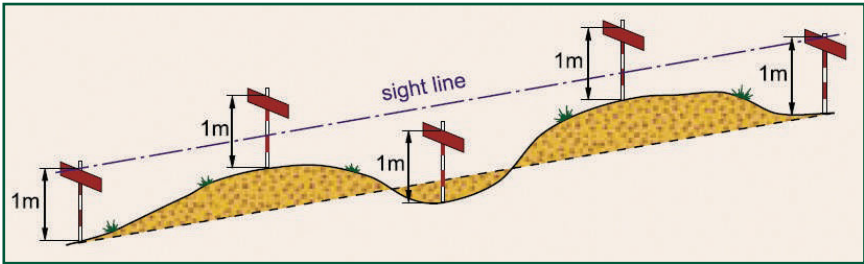


### 5.2.10 Adjusting vertical levels in a drain

Sometime when reshaping or clearing side drains, it is necessary to check that the water will flow as planned. Some of the slope of the existing drain may not provide an even surface for the water to flow and therefore it has to be adjusted. The method shown below, using profile boards to check and control the drain level, provides an effective way of ensuring that water will flow and to correct the water ponding in the side drains and outlet drains of culverts.

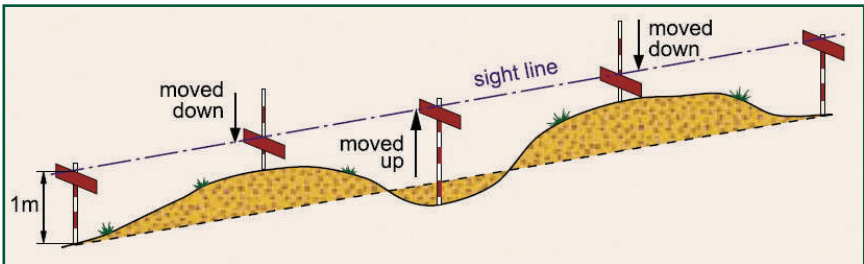
Step 1: First, fix profile boards on the ranging rods along the centre of the drain at a fixed level, one metre above the existing drain level.

**Figure 18:** Fixing ranging rods along the centre of side drains



Step 2: Then sight along the profile boards. Get an assistant to adjust the level of each of the intermediate profile boards so that they are all on line with the first and the last profile. All the profile boards will then be one metre above the completed level of the drain. The excavation of the drain should be 1m from the top of the profile boards.

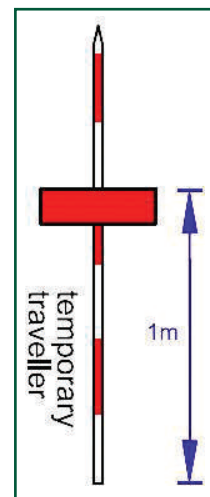
**Figure 19:** Adjusting the profile boards to line of sight



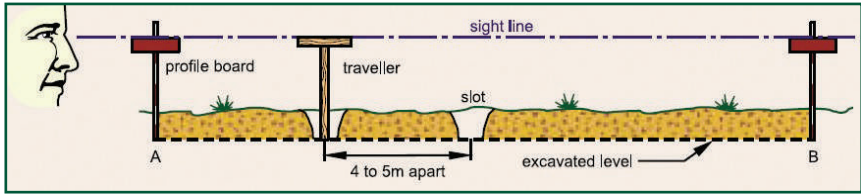
Step 3: Alternatively, a temporary boning rod or traveller can easily be improvised by using the ranging rod upside down with the profile board fixed at 1m from the top of the ranging rod (Figure 20). The labourers should be able to help each other to correct the invert of the side drain by digging or filling as necessary.

To provide good guidance, it is useful to dig slots at regular intervals of 4m to 5m along the sight lines (Figure 21). With sufficient slots, the workers can start clearing the drains by removing the soils between the slots. Finally use the traveller once again to control that the finished level is to the required slope and that there are no high or low spots.

**Figure 20:** Temporary traveller



**Figure 21:** Using the traveller check the drain invert level is excavated to desired depth



### 5.2.11 Setting out outfall (mitre drain)

There are three steps involved in setting out a mitre drain (outfall) which are:

- i. Finding the mitre drain interval
- ii. Setting out the angle for mitre drain
- iii. Setting out the mitre drain ditch for zero excavation

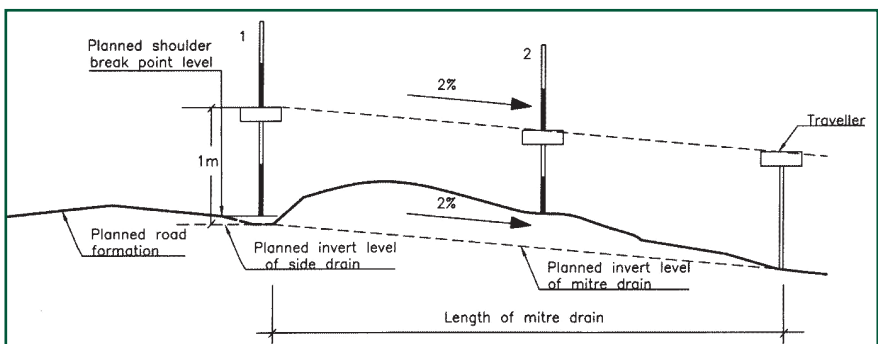
Locations of all outlet and mitre drains should be checked before the final roadbed level is decided upon. This should not come as an afterthought at an advanced stage of construction.

Step 1: Find the gradient of the intended side drain to be constructed using method shown in earlier section in this module. Based on the gradient, refer to mitre drain interval table.

Step 2: Set out the angle of the mitre drain at the point where it should start from the side drain as shown in earlier section in this module.

Step 3: Follow the procedure outlined below to find out up to where the mitre drain should be excavated:

**Figure 22:** Finding end point or length of outfall (mitre drain)



- a. Place boning Rod 1 in the centre of the ditch at the turn out point for the mitre drain and Rod 2 at 10m or 20m down on the centre line of the mitre drain.

- b. Adjust the profile on Rod 1 to 1m above the drain invert level and set out the specified gradient to the profile at Rod 2. (e.g. 2% in this example).
  - c. Sight over the profiles while an assistant moves a travelling rod on the ground along the drain center line away from Rod 2. The traveller rod is a ranging rod with a profile board set at 1m above the end of the rod touching the ground.
- a. The end of the mitre drain is found where all the 3 profiles are flush when sighting through them from one end.
  - b. Measure the distance between Rod 1 and the traveller. If the length of the mitre drain is more than 30m, then try to shorten the length by increasing the gradient. If this is not possible, raise the roadbed level or find another location for the drain.

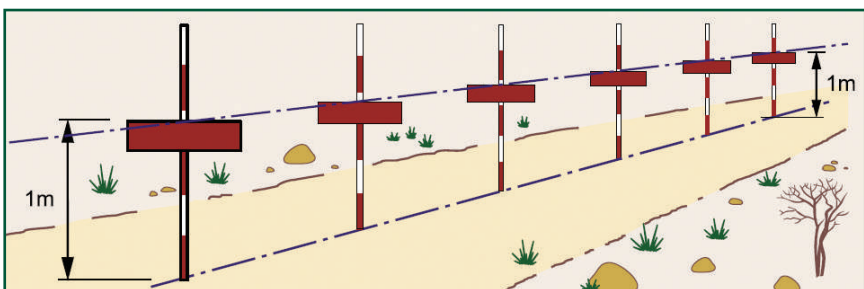
### 5.2.12 Setting out cross section of road

All cross-sections should be set out at right angles to the center-line of the road, as already discussed earlier. The setting out of the road cross-section can effectively be carried out using the same surveying tools and methods described in the earlier Sections in this Module.

#### Procedure:

Step 1: Using the previously established center line, set out ranging rods at 10m intervals along the center line for a section of 50 to 100 meters indicating the profile boards at 1m above the expected level of the shoulder break points (Figure 23).

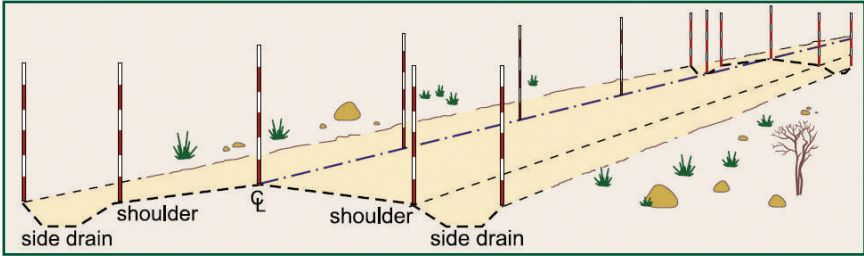
**Figure 23:** *Set out profile boards along the center line ranging rods*



Step 2: At the start of the section, measure out the position of the road shoulder break points and the outer end of the side drains from the center line and mark with ranging rods (Figure 24). Repeat this exercise at the other end of the section.

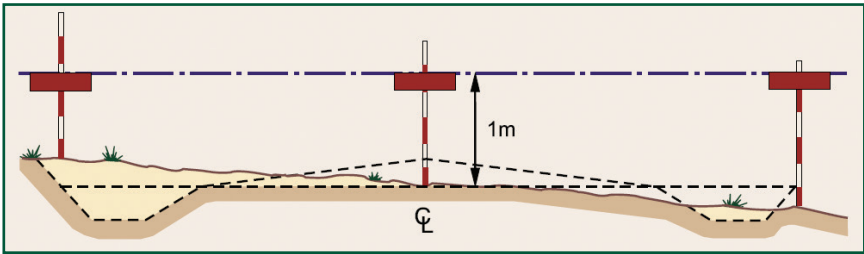


**Figure 24:** Centre line, shoulder break point and outer end of side drains being marked by ranging rods



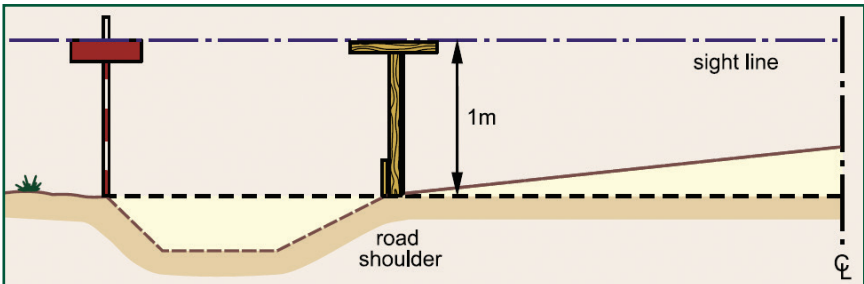
- Step 3: Once the key positions of the road cross section have been set out at the start and the end of a road section, sight in intermediate ranging rods at every 10m along the road shoulder break points and end of side drains. Place wooden peg next to each of the intermediate ranging rods.
- Step 4: Fix profile board at the 1m height of the planned vertical alignment at the ranging rod at the center line and transfer the levels to the profile boards at the outer ranging rods (see Figure 25).

**Figure 25:** Transfer level from the profile board at center line to the outer ranging rods



- Step 5: Transfer these levels to the ranging rods at the outer end of the side drains. Start with the beginning of the road section. Using a string and a line level, transfer the level of the profile board at the centre line to the ditches on both sides of the road (Figure 26). Once the levels are set out with profile boards, mark the levels on pegs next to each ranging rod.

**Figure 26:** Transferring levels using line level and boning rod or profile board

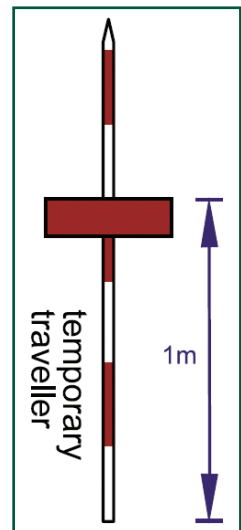


Step 6: Repeat this procedure for the same two ranging rods at the other end of the road section and for any intermediate profile along the center line that was lifted or lowered to reduce excavation works. Then, sight in the intermediate side drain levels.

Step 7: As can be seen in Figure 25 above, the height of the profile on the low side of the center line is more than one meter when the road is passing through terrain with a cross-slope. If there is good natural drainage on the lower side of the road, it may not be necessary to install a drain on this side instead letting the water from the road camber flow off the natural terrain.

Step 8: Mark the levels for the center line on pegs placed next to the ranging rods along the center line. Now, use the center line profile boards to set out intermediate pegs, placed at every 5 m along the center line. This is easily carried out with a one meter tall traveller (Figure 26). Ranging rod placed upside down with the blunt end at the bottom and profile board placed at the 1m height from the blunt end can also be used as a temporary traveller as shown in Figure 27. Mark these pegs at the point where the bottom of the traveller touches the peg, when lined up with the profiles. On all the center line pegs, mark the level of the crest of the camber.

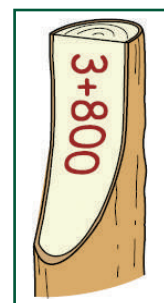
**Figure 27:** *Temporary traveller using ranging rod and profile board*



Step 9: Levels are usually indicated as three-digit numbers, showing the required cut or fill in meters (e.g. +0.20 means that a fill of 20cm is required). When the level is indicated, always measure from the top of the peg (Figure 28).

**Figure 28:** *Survey peg with level written on it*

Step 10: Place the levels of the shoulder break points along the road. For this, it is once again useful to have a traveller. Line up the traveller along the line between two side drain profiles, and the bottom of the traveller will show the correct level of the shoulder.



Step 11: Place pegs every 5m along the edge of the shoulder. Using a traveller, mark these pegs at the point where the bottom of the traveller ends when it lines up with the profiles.

Step 12: Locate and set out the mitre drains as shown in previous section. Make sure that the mitre drains are set out before commencing the excavation works for the side drains and camber.









This training module is produced through a collaborative effort between the International Labour Organization and the National Rural Road Development Agency under the technical assistance component of the World Bank supported Rural Roads Project-II of Pradhan Mantri Gram Sadak Yojana Project (PMGSY).



INTERNATIONAL LABOUR ORGANIZATION  
ILO DWT for South Asia and Country Office for India  
India Habitat Centre  
Core 4B, 3rd Floor, Lodhi Road  
New Delhi-110 003, INDIA



NATIONAL RURAL ROADS DEVELOPMENT AGENCY  
Ministry of Rural Development, Government of India  
5th Floor, 15-NBCC Tower  
Bhikaji Cama Place  
New Delhi-110 066, INDIA